



OFFICE & HOME

**ERGONOMIC**

**ACCESSORY**





Charging Box with UV-C	<b>NEW</b>	01
Monitor Stand with UV-C	<b>NEW</b>	02
Monitor Riser Metallic	<b>NEW</b>	03
Monitor Stand		04~05
Tablet Case iPad 7 & 8 & 9	<b>NEW</b>	06
Tablet Case (For iPad Air 4 (10.9 inch) & iPad Pro 2020 & 2021 (11 inch))	<b>NEW</b>	07
Laptop Riser		08
Accessory & Cooling Pad		09
Tablet Stage / Stand & Smart Phone Stand		10
Arm Rest		11
Sit Stand Keyboard Drawer		12
Foot rest & Anti-Fatigue Mat		13
Copy Holder		14
Charing Box / Tablet / Smartphone		15
Gaming Arm / Gaming Cooling Pad		16

- Multiple ports allowed you to charge up to 10 devices at once.
- An integral UV-C Light Technology disinfects devices during charging.
- With ventilation holes on the front metal door allows the ability to see the sterilization status of UV-C lights.

- 1 Flat key in front to avoid deter theft
- 2 Fixed PC F1 UV resistance plastic dividers with cable management
- 3 Provide cable management and AC adaptor tank
- 4 Easy to replace UV-C light



Flat Key



Cable Management



AC Adaptor Tank

Easy to replace  
UV-C light



UV-C Disinfection

## Charing Box

Model No	DN310VU	
Storage Capacity	10 devices	
Devices Supported	Laptop / Chromebook / Tablet up to 14" screen size	
Cabinet dimension	(L) 411 x (W) 370 x (H) 408 mm	
Charging Type	AC Power strips	
Power Specification	Input: AC 100-120V, 50/60 Hz 12A, AC 200-240V, 50/60 Hz 10A	
Power On/Off switch for UV-C	Available	
Slot Size	(L) 380 x (W) 330 x (H) 271 mm	

Rear



Back



▶ AW40122 UV-C type



NEW



- Monitor Riser up to 27" Screen / 10 Kgs
- Technology: UV-C LED Disinfection
- Wave length: 260 ~ 280 nm
- Life Cycle: 10,000 hours

- UV-C disinfection for Keyboard / Mouse at same time
- Power Light flashing indication in disinfection mode
- Disinfection time required: 900 secs

▶ AW40124 Nature type (without UV-C)



NEW



- Monitor Riser up to 27" / 10 kgs
- Height adjustment from 80/95mm

**Monitor Stand**

Model No	AW40122	AW40124
Material	MLD / Plastic	MLD / Plastic
Color	Black / Brown / White	Black / Brown / White
Max. Loading Weight	10kg	10kg
Dimension	L630 x W213 x H94mm	L630 x W213 x H94mm
Height Adjust	H95mm	H80/H95mm



**NEW**

AW40123 w/ USB HUB



- Monitor Riser up to 32" Screen / 15 Kgs / 9.5 cm
- Metallic Style and Stability Design
- Anti-Slip Rubber Pad
- USB Ports: USB 3.0 x 1, USB 2.0 x 3 ports FCC, CE, RCM, ICES Certified (AW40123)



**NEW**

AW40128 w/o USB HUB



## Monitor Riser

Model No	AW40123	AW40128
Material	Metal, Plastics	Metal, Plastics
Color	Silver and White	Silver and White
Max. Loading Weight	10Kg	10Kg
Dimension	L544.6 x W220 x H90.5mm	L544.6 x W220 x H90.5mm
USB HUB	Yes	No

## Monitor Stand



- Using Transparent/ translucent material to retouch the heavy feeling, but also let ordinary Monitor Stand look fashion and liking.
- Anti-Slipped Rubber to protect not to hurt your table surface.
- Easy adjust height.
- Strawer and Qi charger optional (depend on model).

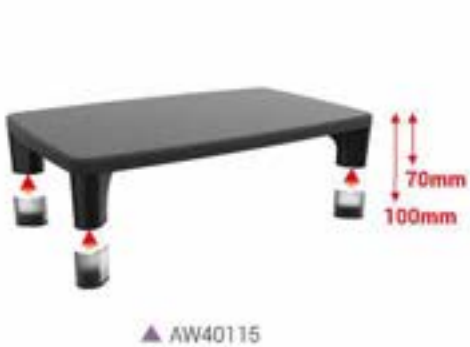

## Monitor Stand

Model No	AW40115	AW40116	AW40117	AW40118	AW40121
Material	MDI / ABS	MDI / ABS	MDI / ABS	MDI / ABS	MDI / ABS
Color	Black	Black	Black	Black	Black
Load	15kg	15kg	15kg	15kg	15kg
Dimension	D240 x W400 x H/0-100mm	D240 x W550 x H/0-100mm	D240 x W550 x H/0-100mm	D240 x W550 x H/0-100mm	D240 x W1000 x H/0-100mm
Height Adjust	/0/100mm	/0/100mm	/0/100mm	/0/100mm	/0/100mm

- Adjustable Height with ergonomic design suitable for users.
- Slim and modern design enhances the visual organization of any desk.



▶ AW40112

Model No	<b>AW40112</b>
Material	Plastic, Wood, Tempered Glass, Aluminum
Color	Black
Load	12Kg
Dimension	L580 x W280 x H114 bmm
Height Adjust	H114 bmm, 134 bmm, 154 bmm



▲ AW40106  
(Height adjustable: 70~100mm)



▲ AW40109



▲ AW40110



▲ AW40111  
stackable with drawer

## Monitor Stand

Model No	AW40106	AW40109	AW40110	AW40111
Material	Plastic	Plastic	Plastic	Plastic
Color	Black & Grey	Black & White	Black & Grey	Black & Grey
Load	20kg	16kg	20kg	16kg
Dimension	L410 x W282 x H95mm	L520 x W348 x H120mm	L360 x W285 x H90mm	L345 x W285 x H60mm

- Shockproof and Non-Slip Design
- 360 Degree Rotatable Handle (AW40323)
- Adjustable Hand Strap (AW40323)
- Kickstand
- Magnetic Closure
- Stylus Pen Holder
- Meet Heavy Duty Drop Protection
- Stiff and Soft Material Combination for Most Shock Absorption



Shockproof



Kickstand



Stylus Pen Holder



360 Degree Rotatable Handle



Adjustable Hand Strap

**NEW**

» Back

Soft shockproof TPR frame

★ iPad & Apple Pencil Not Included.

Stylus pen holder



360° Degree rotatable handle

Non-slip surface

Skin-friendly adjustable hand strap

Kickstand

Anti-slip rubber pad

Magnetic closure



▲ AW40323 with Hand Strap



▲ AW40324



▲ AW40325 with Hand Strap



▲ AW40326

### Tablet Case

Model No.	AW40323	AW40324	AW40325	AW40326
Material	PC / TPR	PC / TPR	PC / TPR	PC / TPR
Color	Black / Trans & Black / Red	Black / Trans & Black / Red	Black / Trans & Black / Red	Black / Trans & Black / Red
Compatible Models	iPad 7 & 8 (10.2 inch)	iPad 7 & 8 (10.2 inch)	iPad Air 4	iPad Air 4
Dimension	L255 x W195 x H34mm	L255 x W195 x H20mm	L251 x W197 x H36mm	L251 x W197 x H20mm



**NEW**

» Back



- Slim and Solid
- Kickstand & Magnetic Closure
- Pen holder with charging
- Detachable and Foldable Magnetic Exterior Cover
- Bump Design for Drop Protection
- Stiff and Soft Material Combination for Most Shock Absorption
- Reserved two holes for shoulder strap installation. (Shoulder strap not included)



Minimalistic



Magnetic exterior cover



Kickstand



Holes for shoulder strap



Pen holder with charging

★ iPad & Apple Pencil Not included.



Detachable and foldable magnetic exterior cover



(Optional)

### Tablet Case

Model No.	AW40327
Material	PC / TPR
Color	Blue
Compatible Models	iPAD Air 4 (10.9 inch) & iPAD Pro 2020 & 2021 (11 inch)
Dimension	L261 x W193 x H19.3mm

## Laptop Riser



- Easily adjust height up and down
- Built in cable management
- Suitable for laptop up to 18"
- Ergonomic design for working on sit and stand
- Height Adjustable: H127~H395mm

### ◀ EMN1012

Model No	EMN1012
Material	ALuminum / Steel / MDF / Plastic
Color	Black
Dimension	D402 x W438 x H429mm
Adjustable	Height



▲ EMN0112 (up to 15°)



▲ EMN0113 (up to 15°)



▲ AW40243 (up to 15°)  
Bottom with Fabric cover,  
friendly for using on lap.



▲ AW40212 (up to 15°)



▲ AW40273 (up to 15°)



▲ AW40204 (up to 15°)

## Laptop Riser

Model No	EMN0112	EMN0113	AW40243	AW40212	AW40273 / AW40277	AW40204
Material	Plastic / Steel	Plastic / Steel	Plastic	Steel / Plastic	Plastic	Plastic
Color	Black	Black	Black	Black & White	Black	Grey
Dimension	D298 x W280 x H203mm	D303 x W325 x H222mm	L352 x W260 x H13mm	L300 x W283 x H46mm	L324 x W274 x H115mm / 180mm	L305 x W315 x H30mm
Adjustable	Height / View Angle	Height / View Angle	N / A	Height / View Angle	Height / View Angle	View Angle

- Compatible with large laptop.
- Silent and powerful fans for excellent cooling performance.
- NB Size (Max):15"



▲ AW40206



▲ AW40237



▲ AW40238



▲ AW40244

## Cooling Pad

Model No.	AW40206	AW40237	AW40238	AW40244
Material	Plastic	Plastic	Plastic	Plastic & Fabric
Color	Silver & White	Black	Black	Black & White
Dimension	L360 x W310 x H50mm	L322 x W250 x H60mm	L300 x W250 x H19mm	L360 x W274 x H31mm



▲ AW40316



▲ AR10309

▲ AR50207  
Sliding Wrist Support▲ EP11728  
Car Mount▲ AW40404  
CPU Holder

## Smart Phone Stand / Car Mount

Model No.	AW40316	AR10309	AR50207	EP11728	AW40404
Material	Plastics+Silicon+TPR+Magnets	ABS	Hips + Pom, EVA	ABS	Plastic
Color	White & Gray or Black & Red	Black or White	Black & Gray	Black	Black & White
Dimension	L190 x W64 x H34mm	L115 x W45 x H42mm	Ø95mm	L425 x W286 x H430mm	L235 x W95 x H160mm

## Tablet Stage / Stand & Smart Phone Stand

- Easy to use for all kinds of tablets.
- Angles adjustable for watching or use for projecting.



▲ EP12016



▲ EP12022



▲ EP12032

### Tablet Stage

Model No.	EP12016	EP12022	EP12032
Material	Aluminum / Steel / Plastic	Aluminum / Steel / Plastic	Aluminum / Steel / Plastic
Color	Black & Silver	Black & Silver	Black & Silver
Load	6Kg	4Kg	4Kg
Dimension	L412 x W80 x H429mm	L325 x W327 x H411mm	L409 x W428 x H430mm



- Modern design for smart phone and tablet use.



▲ AW40246



▲ AW40311



▲ AW40249



▲ AW40317

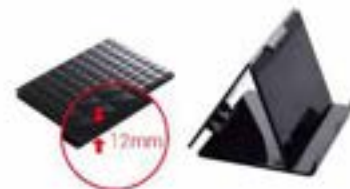

▲ AW40235

### Stand & Smart Phone Stand

Model No.	AW40246	AW40311	AW40249	AW40317	AW40235
Material	Acrylic	Acrylic	Acrylic & Rubber	Acrylic & Rubber	Plastic
Color	Transparent	Transparent	Transparent	Transparent	Black
Load	Ø165 x H41mm	Ø85 x H35mm	L220 x W100 x H45mm	L170 x W138 x H40mm	L450 x W1015 x H12mm



**NEW**



- Easy C-Clamp desk installation.
- Arm support to right hand or left hand users.
- Through Hole Cooling Arm Pad for sweat preventing.
- Easy cleaning with rag or sanitization with alcohol.
- 360 degree wide range free zone movement outside and inside the table edge.

## Arm Rest

Model No	<b>AR20305</b>
Material	Steel / Plastic
Color	Black / Grey & White / Grey
Max. Loading Weight	10kg
Dimension	L200 x W90 x H150mm
Fits to desk in thickness	20-55mm



## Sit Stand Keyboard Drawer



- Full Motion
- 1 ▶ Tilt -15° / 10° with quick release handle
  - 2 ▶ Slide in 17.2" under desk when not in use
  - 3 ▶ Height - Pulling up the arrow zone on keyboard platform to release and elevate 10.2" above or 4.5" under the desk.
    - ▶ Swivel Left or Right 180° Freely

Highest height adjustment to similar models.

Slim design - more free leg room.

Manufactured for stability and durability.

- EVA environmental protection wrist rest included.
- Track included
- Required free space for track installation: 5.5" x 23.6"
- Required desk thickness: 0.8"
- Platform Dim: 10" x 26.5"
- Keyboard Size : under 8" x 19"
- Loading Weight : 10 lb



1 Tilt -15° / 10° with quick release handle



2 Slide in 17.2" under desk when not in use



3 Height adjustment

## Sit Stand Keyboard Drawer

Model No.	AR20207
Material	Metal, Plastics, MDF
Color	Black
Weight	14.5lb
Dimension	L673 x W610 x H165mm
Warranty	1 year

- Easy operation structure and adjusts the foot rest transform for usage sitting or standing.
- Height adjustment for the comfortable posture while sitting or standing.



▲ AR30102

▲ AR30103

▲ AR30104

### Foot rest

Model No	AR30102	AR30103	AR30104
Material	Plastic	Steel pole, Plastic, MDI	Steel, Plastic
Color	Black	Black	Black & Grey
Load	6Kg	4Kg	4Kg
Dimension	L447 x W358 x H106mm	L460 x W354 x H138mm	L474 x W368 x H101mm



- Minimize pressure on the spine and strains on the back muscles to relieve lower back pain.
- Stimulates blood circulation.
- The custom size, color, texture and logo embossed are available.



▲ Customized size, color &amp; texture are available.

### Anti-Fatigue Mat

Model No	AP91001
Material	PU Blended Putiber foam
Color	Black
Dimension	L450 x W600 x H7mm, L600 x W500 x H7mm, L600 x W500 x H7mm, L450 x W750 x H7mm, L750 x W500 x H7mm, Customized size



15-30 Degree Edge Cutting



Anti-slip



Water Proof



Withstand chair casters and can easily roll the chair on to it.





- Adjustable clip- Supports various document or book thickness.
- Dry erase board, convenient for painting, note and message.
- VESA compatible, cleverly designed to attach directly to the monitor via the behind VESA holes.
- The holder base can be used as smart phone stand or tablet stand individually and the inner space is available for charging cable management.
- Reserve pen holder to whiteboard marker pen on holder base.



▲ AR10102



▲ AR10111



▲ AR10112

### Copy Holder

Model No	AR10102	AR10111	AR10112
Material	Plastic	Plastic	ABS, White Board Steel
Color	White & Grey	White & Grey	White & Grey
Dimension	L329 x W264 x H40mm	L329 x W264 x H40mm	L322 x W126 x H286mm





▲ DP310ss



▲ DP310PS



▲ DT310SS



▲ DN310VS



▲ LP105



▲ WN105

## Charing Box

Model No.	DP310SS	DP310PS	DT310SS	DN310VS	LP105	WN105
Device Capacity	10	10	10	10	5	5
Color	White	White	Black	White	Gray	Black
Eq. Dimension (W/D/H)	L242 x W280 x H28mm	L143 x W217 x H23.8mm	L143 x W217 x H23.8mm	L33 x W380 x H271mm	L143 x W302 x H109mm	L35 x W51 x H15mm
Case Dimension (W/D/H)	L400 x W350 x H430mm	L254 x W291 x H380mm	L254 x W291 x H380mm	L570 x W411 x H409mm	L270 x W332 x H573mm	L530 x W105 x 530mm
Charge / Sync	V / V	V / X	V / X	V / X	V / X	V / X
Power Management	USB Hub	USB Hub	USB Hub	AC charge only	USB	AC charge only



- Full-motion articulating monitor mounts provide optimal viewing positions.
- The arm is designed with bright color and modern apparel.
- Mechanical spring provides stable positioning and fluid movement.

- VESA compatible 75 X 75mm and 100 X 100mm.
- Support clamp installation.
- Provide single monitor and dual monitor solutions.

Model No	<b>EM15016</b>	<b>EM45016</b>
Material	Metal	Metal
Color	Black	Black
Weight Load	under 10 Kg	under 15 Kg(Dual Monitor)
Monitor size	Max 21"	Max 21"
Dimension	.600 x W 23 x H 63mm	.600 x W 75 x H 63mm
Product Includes	1 C-Clamp/1 Swivel Arm/1 Spring Arm/1 Monitor brackets	1 C-Clamp/1 Swivel Arm/1 Spring Arm/2 Monitor brackets/1 Coaster

#### EM15016 Single monitor



#### EM45016 Dual monitor



- 4 silent and powerful fans for excellent cooling performance.
- Red LEDs display gaming ambiance.
- Suitable for large laptop, up to 17"
- One button to adjust fan speed and LED brightness.
- 3 port USB HUB.



Fan speed adjustment



3 port USB HUB



SuperCar designed



▲ Angle adjustable to 3 comfortable positions.

#### Gaming Cooling Pad

Model No	<b>AW40322</b>
Material	Plastic
Color	Black & Red
Dimension	L318 x W304 x H41.5mm

# ARM

FOR LCD MONITOR,  
LAPTOP, TABLET



**1~2 Single / Dual Monitor Arm**

EM15016 / Gaming Arm  
EM45016 / Dual Monitor Arm  
EM15046 / Single Monitor Arm  
EM45046 / Dual Monitor Arm

**3 Workstation**

EMC4016

**4~6 Dual Monitor Arm**

EM45216 / Aurora Series Display ARM  
EM43016  
EM43019  
EM43026  
EM43029  
Concise Dual Display Swivel ARM  
EM89016 / Crossbar Dual Monitor ARM

**7 Instruction**

Collocation Diversity / Application Flexibility

**8~9 Modular Features**

**10 1 Monitor**

**11 2~3 Monitor**

**12 4~6 Monitor**

**13~14 Mobile Desk**

SDL2050 / Mobile Desk  
SDL2151 / Mobile Desk Mesh

**15~16 Extension Arm**

**17~18 Ergonomic Arm**

**19 Tablet Arm / Floor Stand**

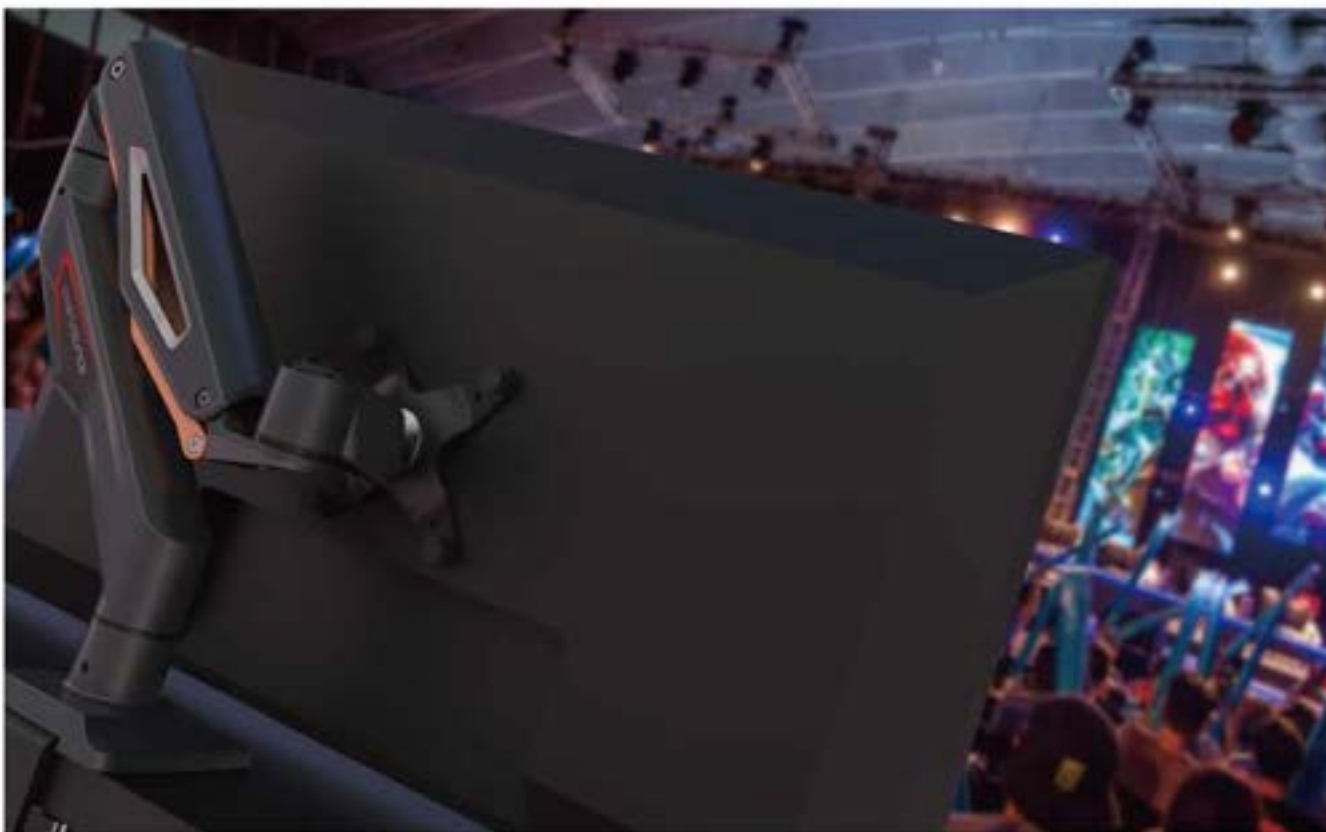

## Gaming Arm

### EM15016

Full-motion articulating monitor mounts provide optimal viewing positions.

The arm is designed with bright color and modern apparel. Mechanical spring provides stable positioning and fluid movement.

VESA compatible 75x75mm and 100x100mm.

Support clamp installation.

Provide single monitor and dual monitors solutions.

### Single monitor

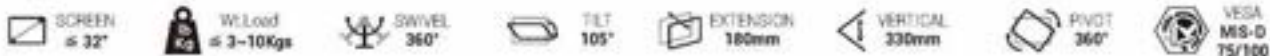

### Dual monitor

#### EM45016



Cable management to keep cable organized.

## Balanca

EM45046 (Dual)

EM15046 (Single)

Allow positioning of your monitor for better productivity, smooth movement helps users to adjust the screen to a comfortable position. Easy to mount and dismount the modularized parts. Push the screen aside to the wall, save your space.



EM45046 ▶



EM15046 ▶

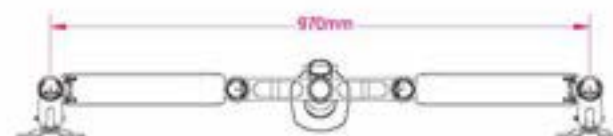

▲ EM45046



## Workstation

EMC4016

The monitor arm is compatible with spring arm and the laptop holder fit a 17-inch laptops. Bring you new experience ever.



## Aurora Series Display ARM

EM45216

Elegant, Stylish and Ergonomic design with high performance, light and slim features designed particularly for individual purpose.

Wide angle and height range for comfortable view position.

Quick release design enables to easily install or dismount the spring arm, swivel arm and monitor bracket cable management function.

Spring calibration display, easy adjustment for weight capacity.

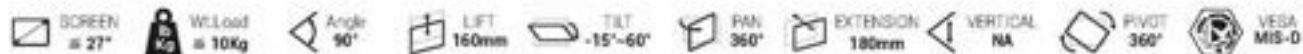

Cable management to keep cable organized.





EM43029

**EM43016 (C-Clamp) / EM43019 (2 in 1)**

SCREEN ≈ 24"	Wt.Load ≈ 20Kg	LIFT 160mm	TILT 105°	PAN 360°	PIVOT 360°	VESA MIS-D
-----------------	-------------------	---------------	--------------	-------------	---------------	---------------

**EM43026(C-Clamp) / EM43029 (2 in 1)**

SCREEN ≈ 27"	Wt.Load ≈ 20Kg	SWIVEL 180°	LIFT 160mm	TILT 105°	PAN 360°	PIVOT 360°	VESA MIS-D
-----------------	-------------------	----------------	---------------	--------------	-------------	---------------	---------------

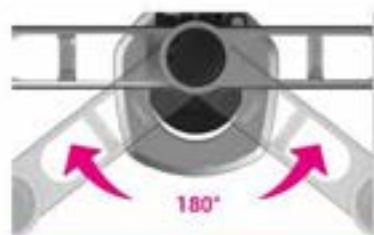

180°

Limitation design to avoid the display hitting on wall



▲ EM43016 / EM43019

▲ EM43026 / EM43029



▲ EM43019

## Concise Dual Display Swivel ARM

EM43016 / EM43019 / EM43026 / EM43029

Elegant, Stylish and Ergonomic design with high performance, light and slim features designed particularly for individual purpose.

Wide angle for comfortable view position.

Limitation design to avoid the display hitting on wall.

Quick release design enables to easily install or dismount the swivel arm and monitor bracket cable management function.



## Crossbar Dual Monitor ARM

EM89016

Accommodates various LCD size, best suitable display size  $\leq 27"$ .

Internal cable management routed cables neatly under crossbar.

Substantial aluminum alloy and metal material design creates steady platform.

Lightly installations to monitor that are compliant to VESA MIS-D 75 x 75mm / 100 x 100mm.

Wide angle for comfortable view position.

Simplified assembly procedure enables easy quick installation.



SCREEN	Wt Load	Angle	LIFT	TILT	PAN	EXTENSION	VERTICAL	PIVOT	VESA
$\leq 27"$	$\leq 10\text{Kg}$	N/A	405mm	$-15^{\circ}-60^{\circ}$	$30^{\circ}$	180mm	NA	$360^{\circ}$	MIS-D



Cable management to keep cable organized.



Quick release bracket for easy installation.

## Collocation Diversity / Application Flexibility

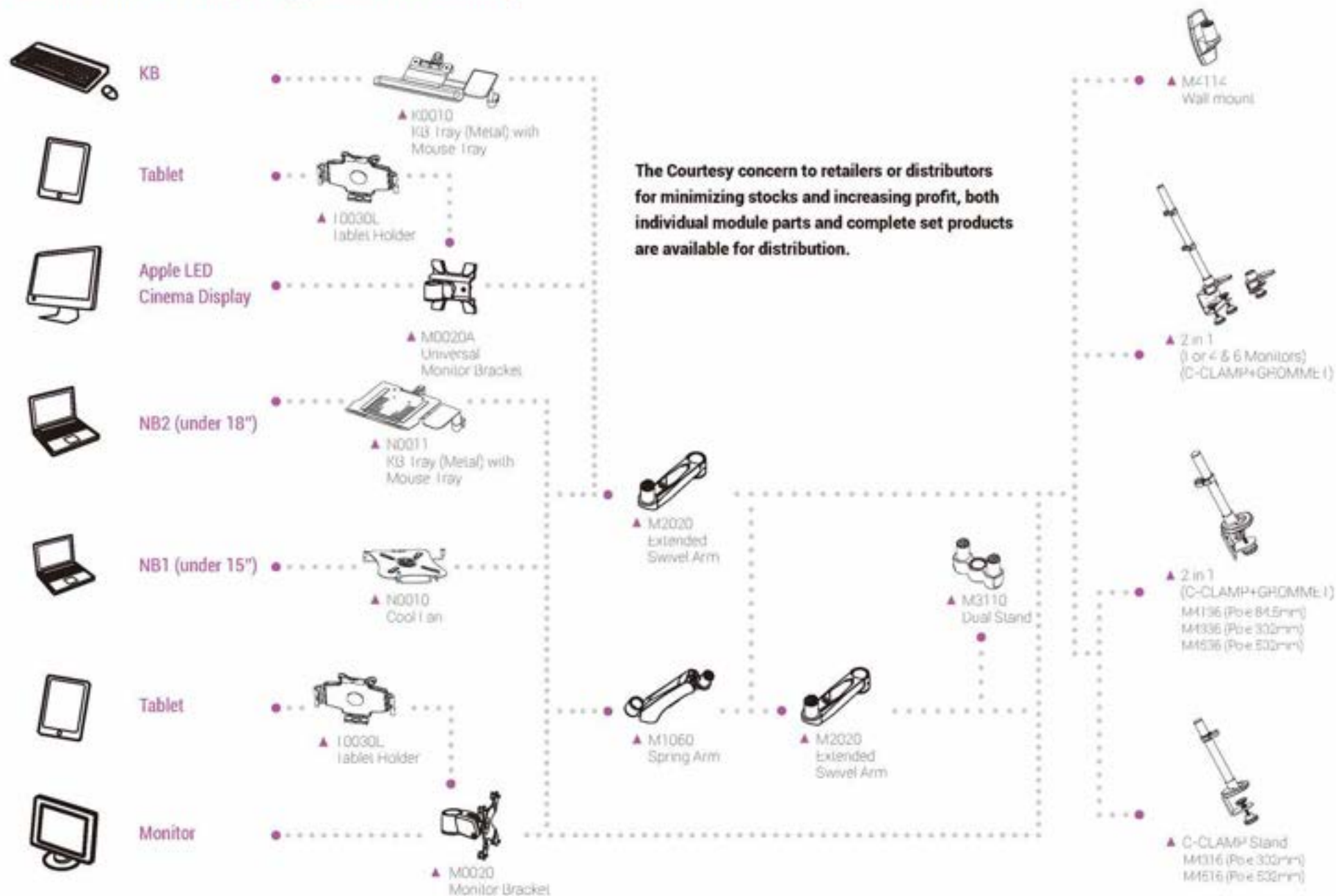

## Features

Wide angle and height range for comfortable view position.

Space saving.

Tool fixed design.



Aurora



Diamond



Robot



Diamond Swivel



Robot Swivel

Swift movement with easy adjustment  
3 quick mode release function as  
Pivot Stand  
Swivel Arm  
Spring Arm



C-Clamp



2 in 1 C-Clamp & grommet



Wall mount

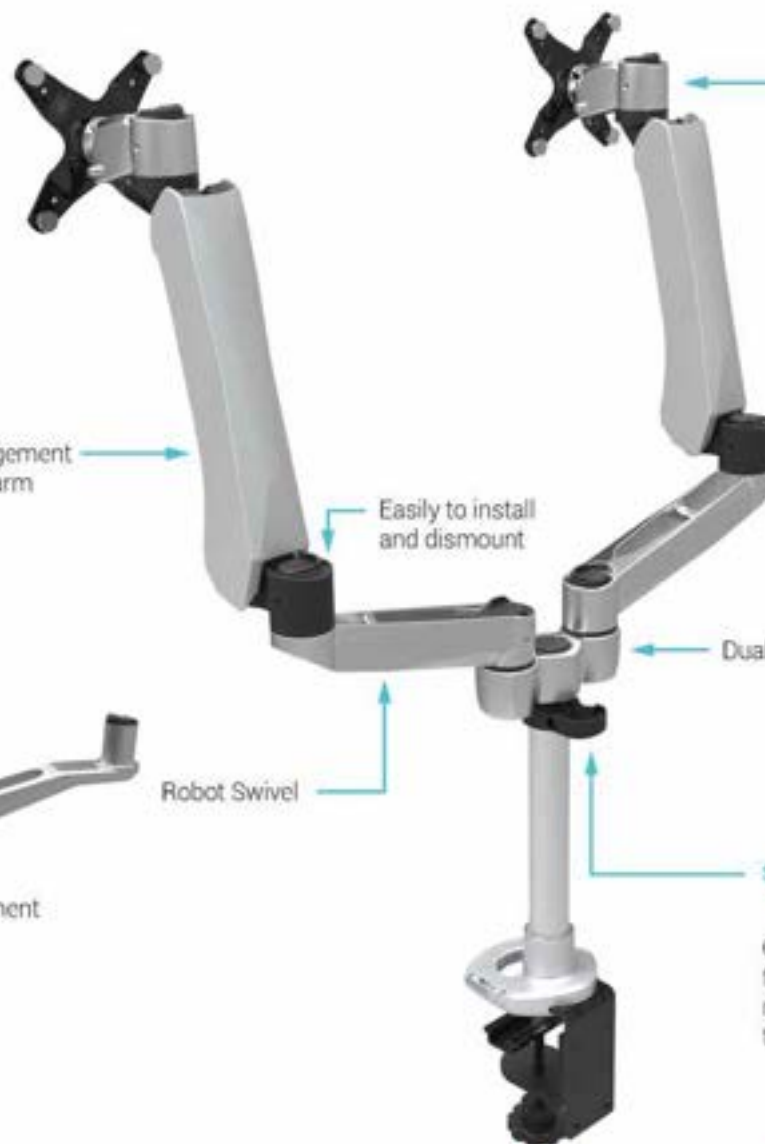

Internal cable management  
neatly under spring arm

Easily to install  
and dismount

Dual stand for 2 monitors

Standard

Considerate tool  
fixed design,  
no more worrying  
tool of placement.

Option

Tool-less adjust  
height

VESA  
MIS-D  
75x75/  
100x100mm



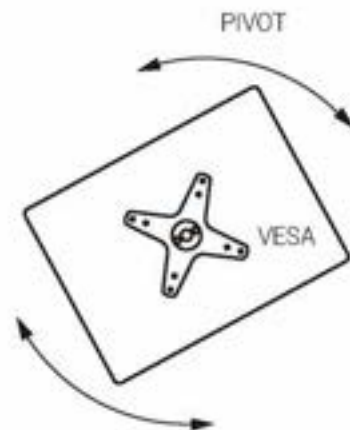
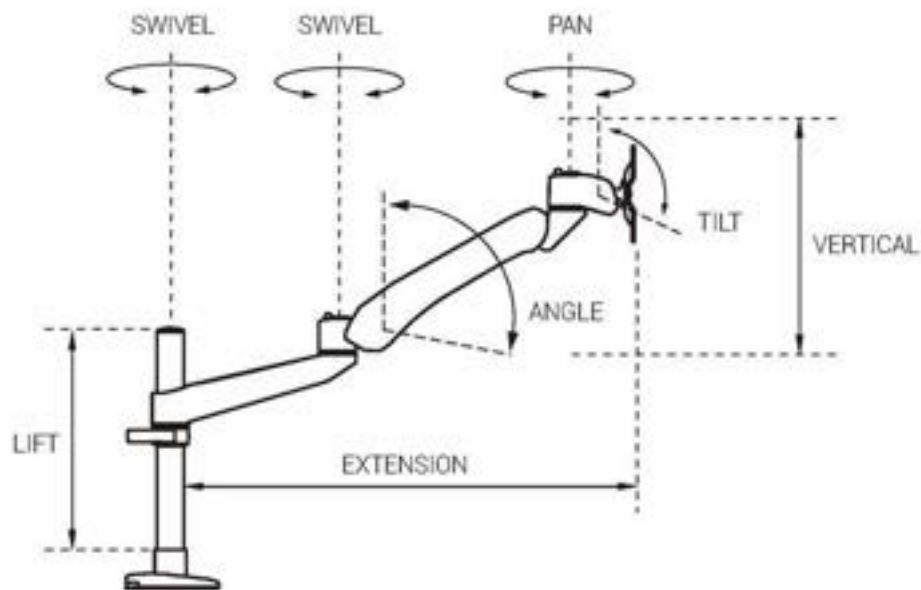

## Mount Type

### Desk Mount

1~3 monitors



#### C-Clamp

Table Thickness:  
20~60mm



#### 2 in 1 C-Clamp+Grommet

Table Thickness:  
20~110mm (C-Clamp)  
20~60mm (Grommet)  
Table Hole:  
10~60mm (Grommet)

4 & 6 monitors



#### 2 in 1 Table Thickness

C-Clamp:20~110mm  
Grommet:20~45mm  
Table Hole for Grommet:  
10~80mm

### Wall Mount



#### Wall Mount

For 1~2 monitor



#### Wall Mount

For 1~2 monitor and  
slat system



#### Wall Mount

For NB ARM and  
Workstation

## 1 Monitor

Wide angle and height range for comfortable view position.  
Swift movement with easy adjustment.  
3 quick mode release function as Pivot Stand,  
Swivel Arm or Spring Arm according to working environment.  
Easily to install and dismount.  
Aluminum and metal material, strong and safety.  
Internal cable management routed cables neatly under Arm.  
Space saving.  
A considerate Tool fixed design, no more worrying tool of placement.

### Mount Type



C-Clamp



Wall Mounted



2 in 1  
C-Clamp+Grommet



▲ Swivel Arm + Spring Arm



▲ Spring Arm



▲ Swivel Arm



▲ Dual Swivel Arm

## 2~3 Monitor



- ◀ **Dual Swivel Arm**  
 Include  
 Monitor bracket x 2  
 Swivel Arm x 4  
 Dual Stand x 1  
 C-Clamp x 1



- ◀ **2 Joint Spring Arm**  
 Include  
 Monitor bracket x 2  
 SPRING Arm x 2  
 Swivel Arm x 2  
 Dual Stand x 1  
 Wall Mount x 1



- ◀ **2 Joint Swivel Arm**  
 Include  
 Monitor bracket x 3  
 Swivel Arm x 3  
 Dual Stand x 1  
 Grommet x 1



- ◀ **Dual Swivel Arm**  
 The mode can combine  
 3 sets 19 inch of monitors  
 at maximum.  
 Include  
 Monitor bracket x 3  
 Swivel Arm x 4  
 Dual Stand x 1  
 2 in 1 Mount x 1

### Mount Type



C-Clamp Wall Mounted



2 in 1  
 C-Clamp+Grommet

### Mount Type



C-Clamp 2 in 1  
 C-Clamp+Grommet

## 4~6 Monitor

### Mount Type



2 in 1  
C-Clamp+Grommet



◀ **2 Joint Spring Arm**  
The mode can combine  
6 sets 23 inch of monitors  
at maximum.

Include  
Monitor bracket x 6  
Spring Arm x 4  
Swivel Arm x 4  
Dual Stand x 2  
C-Clamp x 1



◀ **2 Joint Spring Arm**  
The mode can combine  
4 sets 27 inch of monitors  
at maximum.

Include  
Monitor bracket x 4  
Spring Arm x 4  
Swivel Arm x 4  
Dual Stand x 2  
C-Clamp x 1



◀ **Dual Swivel Arm**  
The mode can combine  
6 sets 19 inch of monitors  
at maximum.

Include  
Monitor bracket x 6  
Swivel Arm x 8  
Dual Stand x 2  
C-Clamp x 1



◀ **2 Joint Spring Arm**  
The mode can combine  
6 sets 19 inch of monitors  
at maximum.

Include  
Monitor bracket x 6  
Spring Arm x 6  
Swivel Arm x 4  
Dual Stand x 2  
Grommet x 1





## Mobile Desk

SDL2050

The Mobile Cart is changed your traditional desk into an free move space. The pneumatic Sit-Stand Mobile Desk Cart provides is 40cm height adjustments, which can perfectly fit for college students or office workers to work free and ergonomically whether in standing or seated position.



### Spec

Product Dim	L699 x W 640 x H 754~1154mm
Brown Box	L780 x W 660 x H 103mm
Material	Metal, MDF, Plastics
Loading Weight	40 kgs

Height Adjustment	75.4~115.4 cm
Gross Weight	18 kgs
Country of Origin	Taiwan
Warranty	1 year

## Mobile Desk Mesh

SDL2151

Enjoy the health benefits of a sit-stand desk and improve your working com-fort in a sedentary workplace. Our multi-purpose mobile laptop desk can serve as podium, learning desk or even a mobile workstation. Adjusts the height of tabletop to improve your posture, allevi-ate your back and neck pains from bad postures instantly.



### Spec

Product Dim	L742mm x W574mm x H1154mm
Brown Box	L780mm x W660mm x H103mm
Material	Metal, MDF, Plastics
Loading Weight	40 kgs

Height Adjustment	75.4~115.4 cm
Gross Weight	15.5 kgs
Country of Origin	Taiwan
Warranty	1 year

## Extension ARM > Single Monitor



		Free Stand		C Clamp					Grommet
	Item No.	EM31222	EM31A22	EM31116	EM32116	EM22116	EM33116	EM23116	EM31111
Angle Adjustment	Swivel	0°		360°					
	Lift Adjustment	380mm		200mm					
	Pivot			360°					
Display Support	Tilt			105°					
	VESA Mounting	MIS-D	MIS-D & Apple	100x100mm, 75x75mm					
	Monitor Panel Size			≤30"					
	Loading Capacity (per Monitor) (Max.)			14Kg					
	Cable Management			YES					
	Material			Steel + Aluminum Alloy + Plastic					



		Grommet				2 in 1 Clamp			
	Item No.	EM31131	EM32111	EM22131	EM33111	EM23131	EM32136	EM22136	EM33136
Angle Adjustment	Swivel					360°			
	Lift Adjustment					200mm			
	Pivot					360°			
Display Support	Tilt					105°			
	VESA Mounting					100x100mm, 75x75mm			
	Monitor Panel Size					≤32"			
	Loading Capacity (per Monitor) (Max.)					14Kg			
	Cable Management					YES			
	Material					Steel + Aluminum Alloy + Plastic			

## Single Monitor / Dual Monitor / Multi Monitor



		2 in 1 Clamp	Wall Mount				C Clamp	Grommet	
Item No.		EM23136	EM31114	EM32114	EM22114	EM33114	EM23114	EM43116	EM43111
Angle Adjustment	Swivel	360°	0°	180°		360°			
	Limitation for Swivel					NO			
	Lift Adjustment	200mm					NO	160mm	
Display Support	Pivot					360°			
	Tilt					105°			
	VESA Mounting					100x100mm, 75x75mm			
	Monitor Panel Size					≤30"			27"
	Loading Capacity (per Monitor) (Max.)					14Kg			10Kg
	Cable Management Material					YES Steel + Aluminum Alloy + Plastic			



		2 in 1 Clamp	Wall Mount	C Clamp	2 in 1 Clamp	C Clamp	2 in 1 Clamp		
Item No.		EM43136	EM43114	EM43016	EM43019	EM53216	EM53236	EM63159	EM73259
Angle Adjustment	Swivel	360°	180°		360°				
	Limitation for Swivel	NO	YES		No				
	Lift Adjustment	160mm	0	160mm	330mm		520mm	440mm	
Display Support	Pivot					360°			
	Tilt					105°			
	VESA Mounting					100x100mm, 75x75mm			
	Monitor Panel Size	≤27"		≤24"		≤19"		≤30"	≤19"
	Loading Capacity (per Monitor) (Max.)	10Kg		10Kg		Pole Loading 20Kg		Pole Loading 45Kg	
	Cable Management Material					YES Steel + Aluminum Alloy + Plastic			

## Ergonomic ARM > Single Monitor



		C Clamp				Wall Mount			
Item No.		EM34116	EM24116	EM35116	EM25116	EM24114	EM35114	EM25114	EM15164
Angle Adjustment	Swivel	360°				180°			
	Lift Adjustment	200mm				NO			
Display Support	Pivot	360°				90°			
	Tilt	105°				155°			
	VESA Mounting	100x100mm, 75x75mm							
	Monitor Panel Size	≤30"							
	Loading Capacity (per Monitor) (Max.)	2~9Kg				7Kg			
Cable Management		YES							
Material		Steel + Aluminum Alloy + Plastic							



		Grommet		2 in 1 Clamp		2 in 1 Clamp		Wall Mount	
Item No.		EM25131	EM15161	EM34136	EM24136	EM35136	EM25136	EM15166	EM34114
Angle Adjustment	Swivel	360°						180°	
	Lift Adjustment	200mm	No	200mm				No	
Display Support	Pivot	360°	90°	360°				90°	360°
	Tilt	105°	155°	105°				155°	105°
	VESA Mounting	100x100mm, 75x75mm							
	Monitor Panel Size	≤30"	≤26"	≤30"				≤27"	≤30"
	Loading Capacity (per Monitor) (Max.)	2~9Kg	7Kg	2~9Kg				7Kg	2~9Kg
Cable Management		YES							
Material		Steel + Aluminum Alloy + Plastic							

## Dual Monitor / Multi Monitor



		C Clamp	2 in 1 Clamp	Wall Mount	C Clamp	2 in 1 Clamp	2 in 1 Clamp	
	Item No.	EM45216	EM45136	EM45114	EM55116	EM55136	EM65159	EM75159
Angle Adjustment	Swivel	360°		180°	360°			
	Lift Adjustment	270mm		0	330mm		520mm	440mm
Display Support	Pivot	360°						
	Tilt	105°						
	VESA Mounting	100x100mm, 75x75mm						
	Monitor Panel Size	≤30"	≤27"		≤24"		≤30"	19"
	Loading Capacity (per Monitor) (Max.)	7Kg	2~9Kg		6.5Kg		2~9Kg	
Cable Management	YES							
Material	Steel + Aluminum Alloy + Plastic							

## Workstation



		Wall Mount		
	Item No.	EMC5114	EMC5034	EMC5334
Angle Adjustment	Swivel	180°		
Height Adjustment for Ergonomic ARM	Height Adjustment Range (Angle)	100°		
	Height Adjustment Range (Distance)	270mm		
	Torque Adjustment	Yes		
Display Support	Pivot	360°		
	Tilt	105°		
	VESA Mounting	100x100mm, 75x75mm		
	Monitor Panel Size	≤30"		
	Loading Capacity (per Monitor) (Max.)	≤9Kg		
	Cable Management	YES		
Material	Steel + Plastic + Aluminum			

## Tablet Arm



		C Clamp	Wall Mount	C Clamp	Wall Mount	C Clamp	Wall Mount	
	Item No.	EPL2716	EPL2116	EPL2164	EPL3116	EPL3164	EPL3316	EPL3364
Angle Adjustment	Arm Swivel	360°		180°	360°	180°	360°	180°
	Arm 1 Tilt Angle	180°		90°	180°			90°
	Arm 2 Tilt Angle		No			200°		
	Holder Tilt Angle		165°			165°		
	Holder Rotate (Pivot)				360°			
	Extended Arm Provided		1			2		
	Height Adjustment		No			478mm		
Tablet Support	Tablet Size	7"~11"		9"~11"			9"~13"	
	Loading Weight (Max.)	800g			1.5kg			
	Locker with Key				YES			
	Cable Management				YES			
	Material	Steel + Plastic + Aluminum						

## Floor Stand



		Floor Stand With Wheel	Floor Stand	Floor Stand	Floor Stand	
	Item No.	EPL1755	EP11765	EP11025	EP11035	
Angle Adjustment	Arm Swivel		Free		No	
	Holder Tilt Angle		165°		280°	
	Holder Rotate (Pivot)		360°		360°	
	Height Adjustment		270mm		455mm	
Tablet Support	Tablet Size		7~11"		9~11"	
	Loading Weight (Max.)			1000g		
	Lock Function	YES		Optional	Yes	Optional
	Cable Management		No		YES	
	Material	Steel + Plastic + Aluminum				

# CHARGING SOLUTIONS



CHEN SOURCE

[www.chensource.com](http://www.chensource.com)



# Product Guide

## USB-C CHARGING CABINET

DU108VS .....	2
WU115VS .....	4

## USB CHARGING CABINET

DT310PS .....	5
---------------	---

## AC CHARGING CABINET

WN112VS .....	7
DN112HS .....	8
DN514VS .....	9

## USB CHARGING CART

TT232PS .....	10
---------------	----

## AC CHARGING CART

TN224VS .....	11
TN130VS .....	12
TN132VS .....	13
MN232VS .....	15
MN142VS .....	16

## CHARGING LOCKER

LN105HS .....	18
---------------	----

## ACCESSORIES

TF70101 .....	19
---------------	----



# DU108VS Charging Cabinet

## Intelligent USB-C Stackable Charging Cabinet for Mobile Devices

- > Securing, protecting and charging up to 8 mobile devices and accommodating most of Chromebooks, laptops and tablets with up to 14" screens.
- > Individual LED light indicating charging and data synchronizing (optional) status.
- > Providing 6 kinds of power settings - 5V, 9V, 10V, 12V, and 15V/3A or 20V/2.25A, for each USB-C port based on USB-C and PD 3.0 charging standard.



Over-Current Protection



Data Sync



Front



Front door open



Side



Rear



### Specification

Capacity	8 Bays
Charging Type	USB-C Charging
Compatibility	≤ 14" Screen Size
Charge / Sync	V / V (optional)
Shelves Type	Adjustable
Dimension (WxDxH)	15.6" x 15.6" x 14.7" / 396 x 395 x 373 mm

**1** LED indicator for charging and sync status, data synchronization through each USB-C port

**2** Sliding door

**3** 1-point steel locking mechanism

**4** Cable management divider

**5** DC Fans

**6** Data Sync / Firmware Upgrade Connection (optional)

**7** Daisy-Chain design (optional)



WU115VS

## Wall Mount Charging Cabinet

Intelligent USB-C Wall Mount Charging and Sync Cabinet for Mobile Devices

- > Securing, protecting and charging up to 15 mobile devices and accommodating most of Chromebooks, laptops and tablets with up to 13" screens.
- > Individual LED light indicating charging and data synchronizing status.
- > It's easy to synchronize data for most of tablets with iOS or Android through Sync functions.



Over-Current Protection



Data Sync



### Specification

Capacity	15 Bays
Charging Type	USB-C Charging
Compatibility	≤ 13" Screen Size
Charge / Sync	V / V
Shelves Type	Fixed
Dimension (WxDxH)	20.9" x 7.1" x 35" / 530 x 180 x 890 mm



1 LED indicator for charging and sync status (each port)

2 3-point key lock

3 DC Fans

4 Data Sync / Firmware upgrade connection

5 Mixture material design in steel and plastic

6 Daisy-Chain



Over-Current Protection



Data Sync



## DT310PS Charging Cabinet

**Intelligent USB Charging Cabinet for Tablets.**

- > Transporting, securing, protecting and charging up to 10 tablets and accommodating most of tablets with up to 10.1" screens.
- > It's easy to synchronize data for most of tablets with iOS or Android through Sync functions.
- > Providing DC 5V/2.4A power from each USB port based on USB charging standard (BC 1.2).

### Specification

Capacity	10 Bays
Charging Type	USB Charging
Compatibility	≦ 10.1" Screen Size
Charge / Sync	V / V
Shelves Type	Adjustable
Dimension (WxDxH)	15.8" x 13.8" x 16.9" / 400 x 350 x 430 mm

Optional Accessories



WALL MOUNT KIT







Over-Current  
Protection



## WN112VS Wall Mount Charging Cabinet

### Modern Charging Cabinet for Mobile Devices

- > Securing, protecting and charging up to 12 mobile devices and accommodating most of Chromebooks, laptops and tablets with up to 13" screens.
- > It's an easy and convenient way to manage and install cables and AC adapters with the Cable and AC adapter Management.
- > The daisy-chain design allows users to enable up to two cabinets through a single wall outlet.

### Specification

Capacity	12 Bays
Charging Type	AC Charging
Compatibility	≤ 13" Screen Size
Charge / Sync	V / X
Shelves Type	Fixed
Dimension (WxDxH)	20.9" x 7.1" x 35" / 530 x 180 x 890 mm

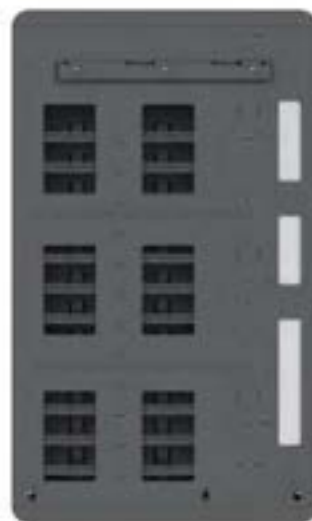



# DN112HS

## Charging Cabinet

### Compact Charging Cabinet for Mobile Devices

- > Securing, protecting and charging up to 12 mobile devices and accommodating most of Chromebooks, laptops and tablets with up to 14" screens.
- > It's an easy and convenient way to manage and install cables and AC adapters with the cable management and AC adapter bracket.
- > The cabinet can provide smart charging by simply connecting an optional Smart Charging Controller (Model: TF70101).



Over-Current  
Protection



### Specification

Capacity	12 Bays
Charging Type	AC Charging
Compatibility	≤ 14" Screen Size
Charge / Sync	V / X
Shelves Type	Sliding
Dimension (WxDxH)	16.5" x 23.2" x 25.8" / 420 x 590 x 656 mm

### Optional Accessories



TF70101  
Smart Charging Controller



Caster Set



Caster Set  
(with brake)





Over-Current Protection



## DN514VS Charging Cabinet

Compact Charging Cabinet for Mobile Devices

- > Securing, protecting and charging up to 12 mobile devices and accommodating most of Chromebooks, laptops and tablets with up to 14" screens.
- > It's an easy and convenient way to manage and install cables and AC adapters with the cable management and AC adapter tank.
- > The cabinet can provide smart charging by simply connecting an optional Smart Charging Controller (Model: TF70101).

### Specification

Capacity	14 Bays
Charging Type	AC Charging
Compatibility	≦ 14" Screen Size
Charge / Sync	V / X
Shelves Type	Fixed
Dimension (WxDxH)	30" x 16.2" x 16.1" / 760 x 411 x 408 mm



Optional Accessories



TF70101  
Smart Charging Controller



Caster Set



Caster Set  
(with brake)



Wall Mount Kit



# TT232PS

## Charging Cart

### Intelligent USB Charging Cart for Tablets

- > Transporting, Securing, protecting and charging up to 32 tablets and accommodating most of tablets with up to 13" screens.
- > It's easy to synchronize data for most of tablets with iOS or Android through Sync functions.
- > Providing DC54V/2.4A power from each USB port based on USB charging standard (BC 1.2).
- > It's an easy and convenient way to manage and install cables with the Cable Management.



Over-Current  
Protection



Data Sync



Front



Rear



### Specification

Capacity	32 Bays
Charging Type	USB Charging
Compatibility	≤ 13" Screen Size
Charge / Sync	V / V
Shelves Type	Fixed
Dimension (WxDxH)	32.2" x 21.7" x 36.6" / 820 x 552 x 930 mm





## TN224VS Charging Cart

### Essential Charging Cart for Mobile Devices

- > Securing, protecting and charging up to 24 mobile devices and accommodating most of Chromebooks, laptops and tablets with up to 15.6" screens.
- > It's an easy and convenient way to manage and install cables and AC adapters with the cable management and AC adapter bracket.

### Specification

Capacity	24 Bays
Charging Type	AC Charging
Compatibility	≅ 15.6" Screen Size
Charge / Sync	V / X
Shelves Type	Fixed
Dimension (WxDxH)	30.3" x 21.7" x 38.5" / 820 x 552 x 930 mm

Front



Rear



# TN130VS

## Charging Cart

### Digital Cycle Charging Cart for Mobile Devices

- > Transporting, Securing, protecting and charging up to 30 mobile devices and accommodating most of Chromebooks, laptops and tablets with up to 15.6" screens.
- > Built-in digital cycle charging processor is to charge mobile devices with 15 minutes per cycle without complicated mode settings or adjustments.
- > It's an easy and convenient way to manage and install cables and AC adapters with the cable management and AC adapter bracket.



Over-Current  
Protection



Front



Rear



### Specification

Capacity	30 Bays
Charging Type	AC Charging
Compatibility	≤ 15.6" Screen Size
Charge / Sync	V / X
Shelves Type	Fixed
Dimension (WxDxH)	25.9" x 23.1" x 37" / 658 x 588 x 940 mm

1 5" Casters



2 Padlock



3 Divider



4 AC Adapter Bracket

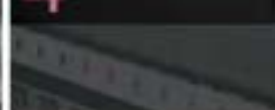

5 Power Cord Management



6 US Power Strips





## TN132VS Charging Cart

### Intelligent Charging Cart for Mobile Devices

- > Transporting, Securing, protecting and charging up to 32 mobile devices and accommodating most of Chromebooks, laptops and tablets with up to 15.6" screens.
- > Optimizing charging time and preventing electrical overloading to ensure devices charged safely.
- > It's an easy and convenient way to manage and install cables and AC adapters with the cable management and AC adapter bracket.

### Specification

Capacity	32 Bays
Charging Type	AC Charging
Compatibility	≦ 15.6" Screen Size
Charge / Sync	V / X
Shelves Type	Fixed
Dimension (WxDxH)	31.8" x 23.1" x 37" / 808 x 588 x 940 mm

Front



Rear







Over-Current  
Protection



## MN232VS Charging Cart

### Intelligent Charging Cart for Mobile Devices

- > Transporting, Securing, protecting and charging up to 32 mobile devices and accommodating most of Chromebooks, laptops and tablets with up to 15.6" screens.
- > Optimizing charging time and preventing electrical overloading to ensure devices charged safely
- > It's an easy and convenient way to manage and install cables and AC adapters with the cable management and AC adapter bracket.

### Specification

Capacity	32 Bays
Charging Type	AC Charging
Compatibility	≦ 15.6" Screen Size
Charge / Sync	V / X
Shelves Type	Sliding
Dimension (WxDxH)	28.1" x 24.4" x 40.7" / 715 x 621 x 1035 mm





# MN142VS

## Charging Cart

### Intelligent Charging Cart for Mobile Devices

- Transporting, Securing, protecting and charging up to 42 mobile devices and accommodating most of Chromebooks, laptops and tablets with up to 15.6" screens.
- Optimizing charging time and preventing electrical overloading to ensure devices charged safely.
- It's an easy and convenient way to manage and install cables and AC adapters with the cable management and AC adapter bracket.

Front



Rear



Over-Current  
Protection



### Specification

Capacity	42 Bays
Charging Type	AC Charging
Compatibility	≤ 15.6" Screen Size
Charge / Sync	V / X
Shelves Type	Sliding
Dimension (WxDxH)	34.9" x 24.4" x 40.7" / 887 x 620 x 1035 mm





LN105HS

## Charging Locker – Electronic Type

### Charging & Securing mobile devices with smart lockers

- > Charging and securing mobile devices, such as Chromebooks, laptops and tablets with up to 17" screens.
- > Providing one AC power outlet and one or two DC5V/2.4A USB charging ports for devices.
- > LED illuminating when doors open.
- > The panel with LED green/red light indicating door lock/unlock and charging status.
- > Administrators can Unlock or Reset the user codes with master codes.
- > The daisy-chain design allows users to enable up to two cabinets through a single wall outlet.



Over-Current  
Protection



### Specification

Capacity	5 Bays
Charging Type	AC x 1 + USB (DC5V/2.4A)
Compatibility	≤ 17" Screen Size
Charge / Sync	V / X
Shelves Type	Fixed
Dimension (WxDxH)	17.5" x 19" x 22.6" / 445 x 482 x 573 mm





Over-Current Protection



# TF70101 Smart Charging Controller

## Charging Efficiently & Safely

- > Able to detect and identify the power current status.
- > Implementing to maximize charging efficiency and minimize charging time.
- > Administrators can schedule charging time through RS232 port.
- > Smart Charging Technology.

### Specification

Capacity	3 + 1 port
Charging Type	AC Charging
Outlet Type	US or IES
Smart Charging	V
AUX Power	V



### US Type



### IEC Type

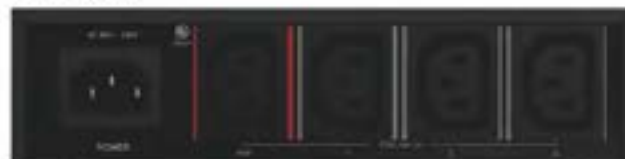

### SmartAdmin Software (for window OS)

Administration Platform

Scheduler



**CHEN**SOURCE

Tel: +886-3-316 2789

E-mail: [chensource@chensource.com](mailto:chensource@chensource.com)

Add: No.50-13, Sec. 1, Minsheng N. Rd., Guishan District,  
Taoyuan City 33391, Taiwan

